

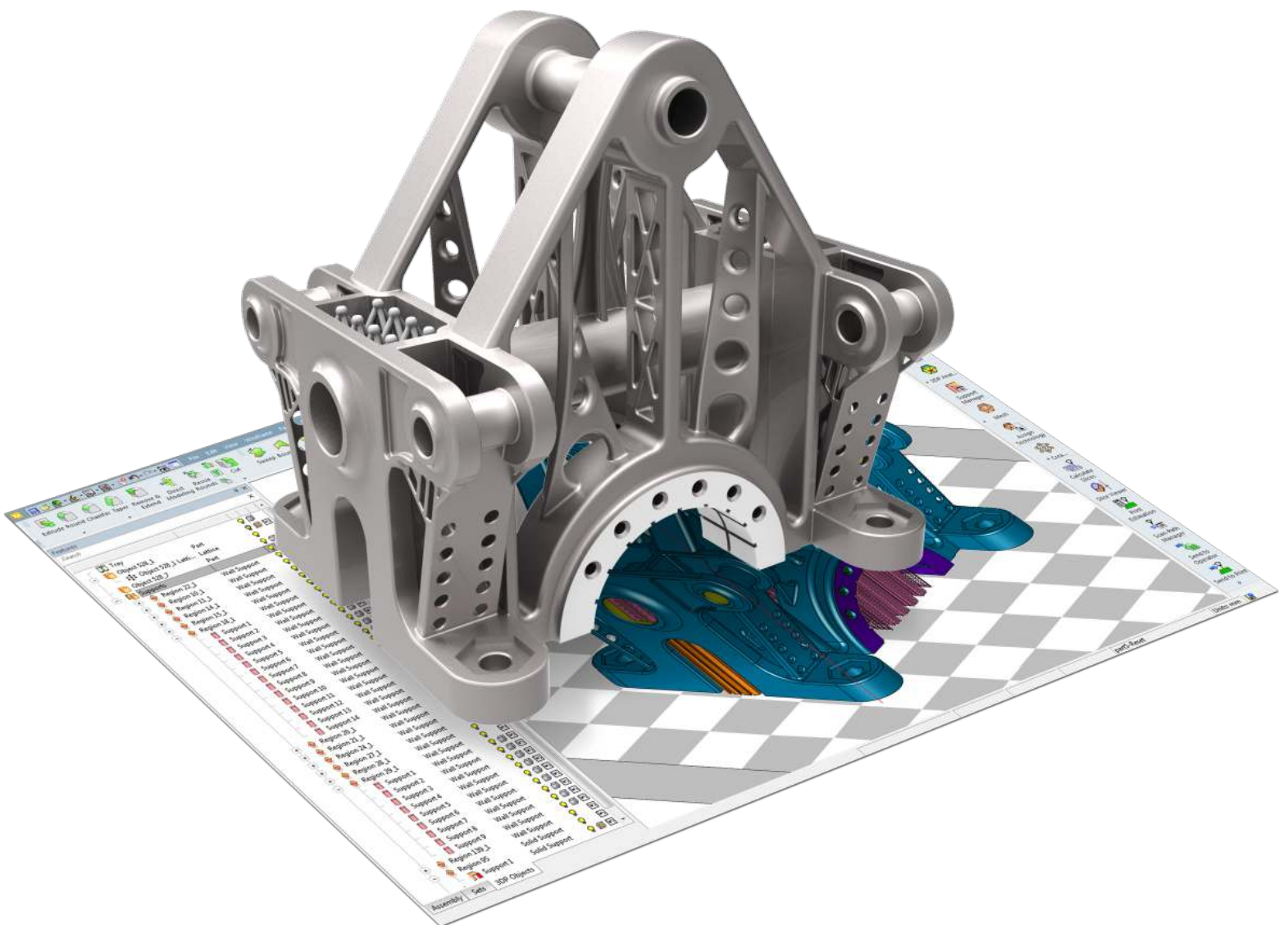

3DXpert

All-in-One Integrated Software for Additive Manufacturing (AM)



OQTON



3DXpert

Minimize Lead Time to High Quality Printed Parts

3DXpert is an all-in-one integrated software to prepare, optimize and manufacture 3D CAD models using additive manufacturing (AM). Supporting every step of the additive manufacturing workflow from design to post-processing, 3DXpert streamlines your process to quickly and efficiently transition from a 3D model to a successfully printed part.

This powerful software enables you to:

- **Achieve successful, quality prints** - Prepare designs for additive manufacturing
- **Optimize design structure** - Get the most out of additive manufacturing with lighter weights, enhanced functional properties, etc.
- **Shorten design to manufacturing lead time** - Streamline your preparation and optimization workflow
- **Minimize manufacturing Total Cost of Operation (TCO)** - reduce print time, material consumption and failed builds.

3DXpert Workflow – from Design to Manufacturing

A single, integrated software solution simplifies your workflow and removes barriers to production. 3DXpert gives you complete flexibility and control over the entire of additive manufacturing process to develop and produce parts costeffectively.

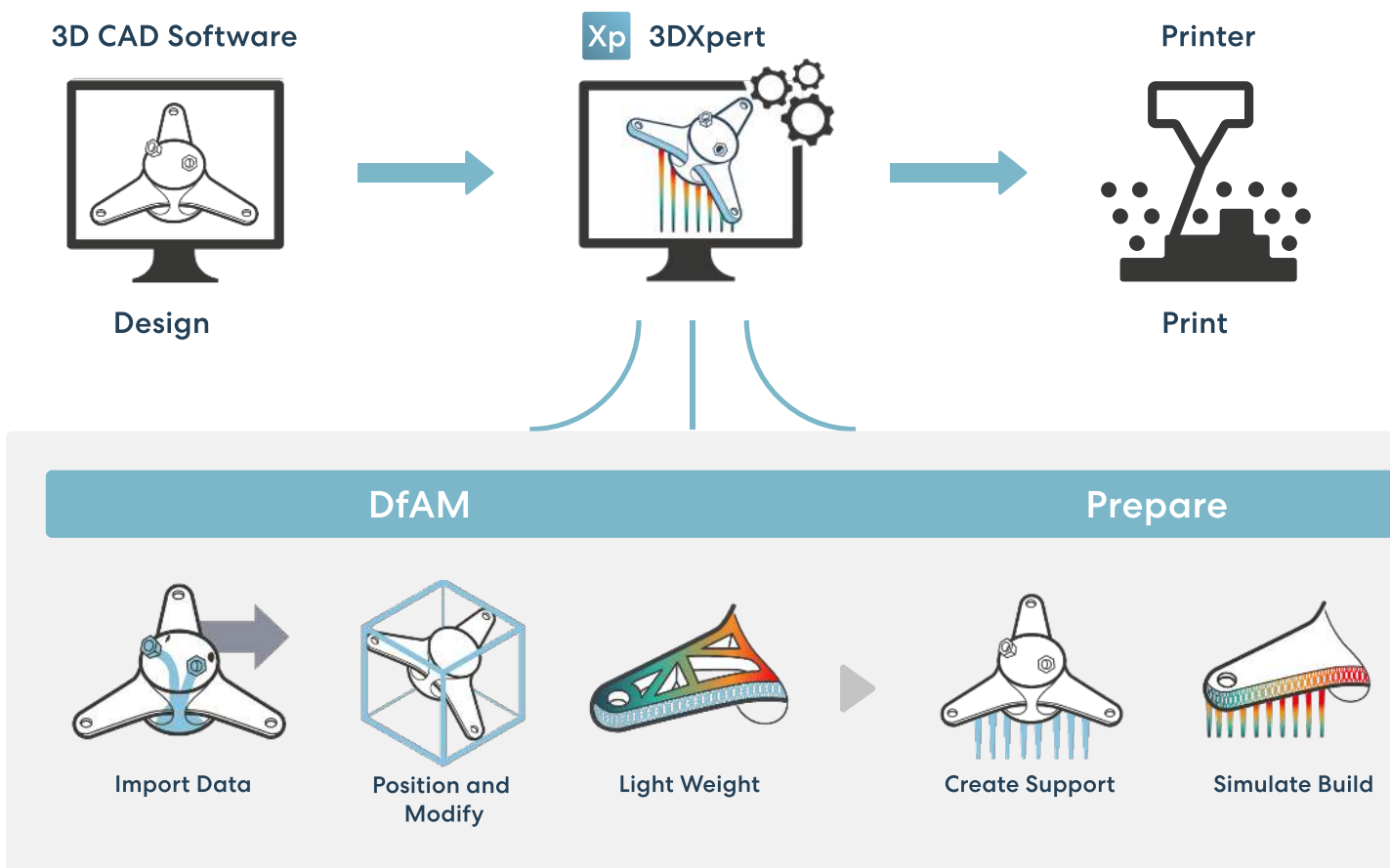

All-In-One Integrated AM Software

Avoid lengthy iterative process across multiple software solutions with all-in-one integrated software.

Greater Agility, Quality and Speed with Hybrid CAD

Seamlessly work with both B-rep (solids and surfaces – e.g. STEP, IGES as well as direct read from all major CAD vendors), mesh formats (e.g. STL, 3MF, etc.) and Voxels (VDB). This eliminates the need to convert solid or surface data into mesh and improves data quality and integrity.

Facilitate Changes at Any Stage with History-based CAD Tools

Easily apply changes and edits to the model at any stage of the process, using history-based parametric CAD tools to avoid losing the work you have done so far.

Reduce Weight and Material Usage with DfAM (Design for Additive Manufacturing)

Lower part weight, material usage and printing time and enhance functional part properties while complying with the part mechanical specifications with Generative Design, Implicit Modeling, and fast creation, editing and visual manipulation of lattice-based structures (volume and surface texture).

The Ultimate Combination of Automation and Full User Control

Get an ideal mix of full automation using a programming free scripting environment, along with unprecedented manual control to optimize the entire design and manufacturing process. Use pre-defined parameters specific to each printer, material, and print strategy or develop your own, controlling scan-path calculation methods and parameters.

Minimize Tryouts with Build Simulation

Integrated build simulation in the design environment provides fault prediction for the entire manufacturing process, and allows corrections to be applied easily before sending parts to print. Minimizing the costly and time-consuming number of tryouts ensures a repeatable and accurate manufacturing process with lower cost and time.

Shorten Print Time and Ensure Quality with Optimized Printing Strategies

Assign optimal print strategies to different zones of the part and automatically fuse them into a single scan-path to minimize print time while maintaining part integrity. Optimized printing strategies take into account the design intent and part geometry to create an effective scan-path that addresses the challenges of 3D printing.

Manufacture

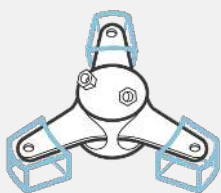

Setting
Printing Strategies

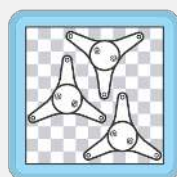

Arrange
Build Platform

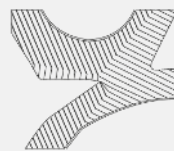

Calculate
Scan-Path



Stabilize Thermal
Behavior

DfAM

OPTIMIZE YOUR DESIGN FOR ADDITIVE MANUFACTURING

Import Data

IMPORT PART AND MAINTAIN CAD INTEGRITY

- **Any CAD format** - import data from all CAD formats (STEP, IGES, VDA, DXF, Parasolid (including binary), SAT, SAB (ACIS)), native read formats including PMI data (such as SolidWorks, CATIA, Creo Elements/Pro, Siemens NX, Autodesk Inventor, and SolidEdge) as well as virtually all mesh formats (e.g. STL, 3MF, OBJ, PLY, JT), and Voxal data (through the VDB format).
- **Maintain CAD integrity** - continue working with B-rep data (solids and surfaces) without downgrading to mesh, maintain data integrity including analytic geometry, part topology and color-coding.
- **Analyze for printability** - printability checks and automated healing of both STL and B-rep geometry.

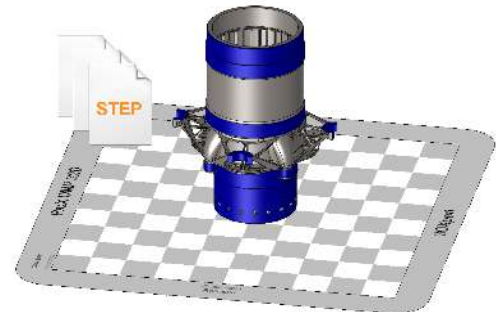

Position & Modify

ENSURE PRINTABLE GEOMETRY

Orient and Position

- **Real time analysis** - receive immediate feedback on how part orientation impacts support areas, down-facing areas, approximated stress, print time and material consumption.
- **Set orientation constraints** - select faces or facets that should receive no supports or should not face downwards to ensure best surface quality.
- **Automated best fit positioning** - follow automated suggestions for part orientation that comply with predefined minimum criteria (e.g tray area usage, amount of supports, printing time, stress) or provide user-defined settings for each criterion priority.
- **Visualize print environment** - view build tray volume, gas flow and recoater/roller directions.

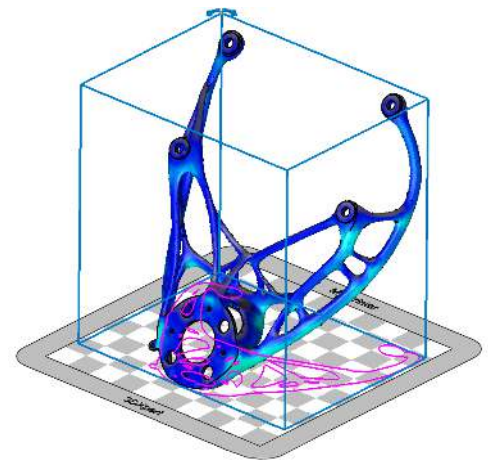

Modify

- **Parametric and history-based hybrid CAD toolset** - use a rich set of parametric and history-based hybrid (b-rep and mesh) CAD tools as well as advanced direct modeling tools to improve part printability and prepare for post-processing operations (e.g., close holes and add material for machining).
- **Facilitate ECO (Engineering Change Order)** - automatically apply all design operations performed on a previous model version to an imported updated one, replacing time consuming manual operations with a fast, automated process.



Light-Weighting

SAVE ON WEIGHT, MATERIAL AND PRINTING TIME

- **Generative design** - dramatically reduce the volume and mass of your parts, while maintaining or enhancing physical and functional properties, using an automated iterative design process and cutting-edge technology.
- **Implicit modeling** - design extremely complex geometries using the most efficient tools available utilizing mathematical functions to describe shapes.
- **Volumetric lattice and infill structures** - hollow out parts while maintaining their shape and meeting their mechanical specifications. Use conformal structures that can take on the shape of the part.
- **Surface texture** - apply printable and conformal textures to achieve the required texture for each surface. Use web-lines to add structural strength to the part.
- **Lightning-fast optimization** - groundbreaking technology allows for extremely fast creation, editing, and visual manipulation of lattice structures, combined with history-based parametric features.
- **Flexible automation** - use a rich library of pre-defined lattice structures; design your own unit cell lattice structures and cell progression or import lattice structures designed in other systems.
- **Lattice optimization** - run an FEA stress analysis on lattice structures, and optimize lattice elements based on that analysis to meet functional properties requirements while keeping weight, material usage and printing time to a minimum.

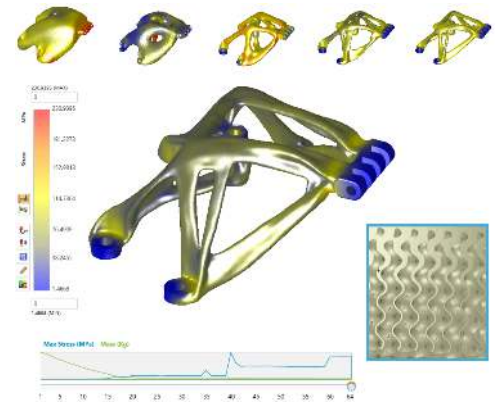

Prepare

PREPARE YOUR PART FOR PRINTING AND OPTIMIZE PRINT TECHNOLOGY TO LOWER THE COST

Design Supports

ENSURE QUALITY PRINTS WITH MINIMAL SUPPORTS

- **Analyze supports requirements** - automatically or manually identify regions requiring supports.
- **Fully automated support creation** - generate supports for the entire part with a single click using the "Power Supports".
- **Easy creation** - automatic supports setup based on best practice templates or your own templates.
- **Any type** - select supports types from a rich library including wall, lattice, solid, cone, skirt and more.
- **Full control** - use a rich toolset to fragmentize, tilt, and offset supports to simplify their removal and minimize material requirements. Save your support structures as templates for future use..

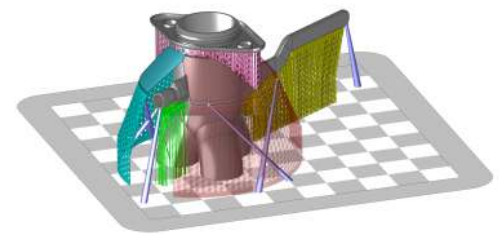

Simulate Build

MINIMIZE TRYOUTS TO SHORTEN LEAD TIME AND CUT PRODUCTION COST

- **End-to-end fault prediction** - predict issues that might result in build failure or damage to the printer before sending the part to print. Verify proper part orientation and support design, and analyze the effects of taking the part off the build plate, removing supports, and applying heat treatment.
- **Integrated within the design environment** - easily apply corrections without going back-and-forth between multiple software solutions.
- **Offload simulation** - offload calculations to a separate computing platform and continue with your design work.
- **Detect defects early on** - receive layer-by-layer simulation results without waiting for the entire simulation process to complete.
- **Compensated model** - use a geometrical model that offsets the deviations created during printing, as a reference for adjustments to ensure the printed part matches the digital model.

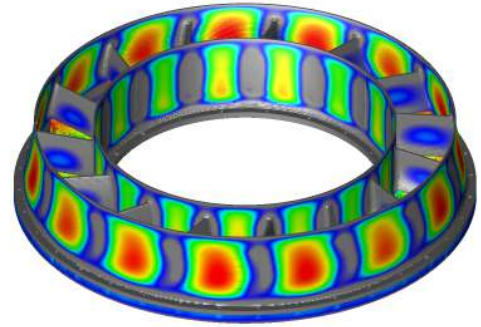

Optimize Printing Strategies

SHORTEN PRINTING TIME WHILE ENSURING DESIRED QUALITY

- **Easily define areas** - utilize the patent pending 3D Zoning to define virtual volumes using objects created with automated feature recognition tools, or by standard CAD operations, and assign specific print strategies to those volumes.
- **Shorten printing time** - automatically and manually assign optimal print strategies to relevant objects (e.g. supports, lattices, internal volumes, small features, high quality surface, circular area), matching required quality with printing speed and accuracy.
- **Maintain part integrity** - eliminate the need to divide the part into separate objects and use automated fusion of zones with different printing strategies to avoid weak spots and seam lines.
- **Supportless printing** - eliminate supports by setting multi-exposure special printing strategies to ensure printing integrity without support generation.

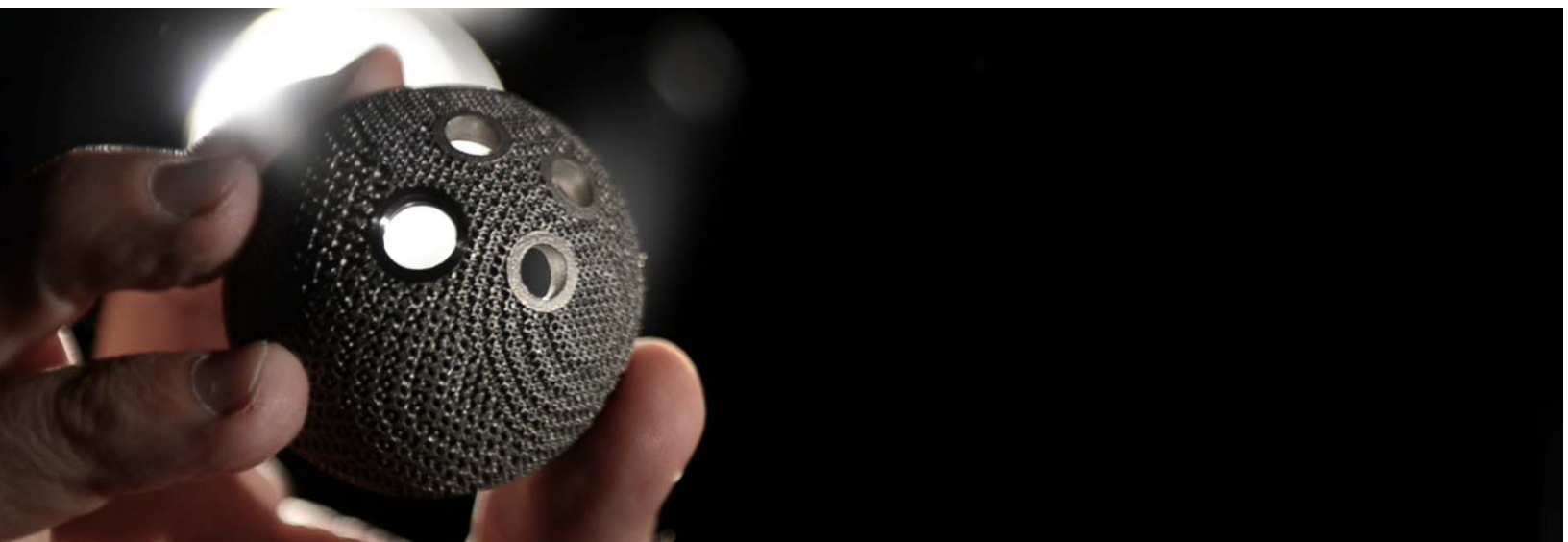
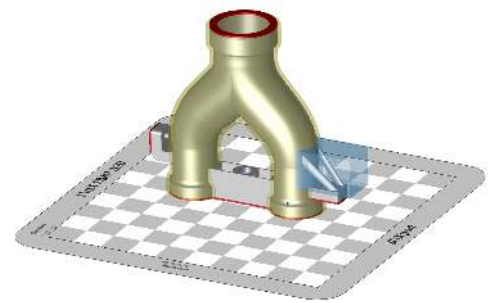

Manufacture

SLICE, ARRANGE, VALIDATE AND SEND TO PRINT

Arrange Build Platform

EASILY POSITION MULTIPLE PARTS FOR BEST UTILIZATION OF TRAY AREA

- **Arrange tray** - automatically position and nest (2D and 3D) the parts on the build platform to best utilize the printing volume while eliminating collisions and interlocking, and create a united optimal scan-path for the entire build.
- **Labeling** - add labels to each of the parts placed on the tray or the tray itself to make them easily identifiable and combine their scan path with the build scan path.
- **Verification** - use a range of analysis tools to ensure all parts are ready for printing, view the combined scan path and estimations for print time, material consumption, and overall costs.

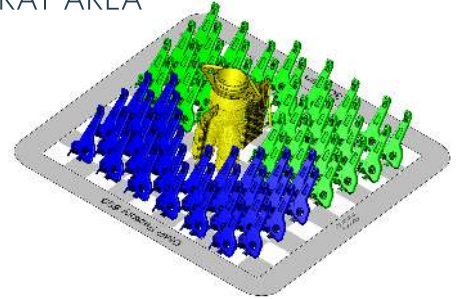

Calculate Scan-Path

OPTIMIZE SLICING & HATCHING TO ENSURE REPEATABILITY AND QUALITY

- **Intelligent “scan-path” calculation** - combining control over print head (including autobalancing for 3D Systems DMP multi-laser printers) with zoning and part geometry to increase throughput while maintaining print quality.
- **Shorten calculation time** - Offload and distribute the calculation to additional computers. Quick and accurate preview of the actual “scan-path” for selected slices prior to fully calculating the entire part.
- **Ultimate flexibility** - get the most out of your printer using pre-defined best practice parameters for each machine, material, and print strategy, or develop your own printing strategies with unprecedented control over “scan-path” calculation methods and parameters.
- **Validate the print process** - navigate through the motions of the calculated “scan-path” per each layer through the slice viewer.
- **Send to printer** - send to printer as “scan-path” information, generic CAD format (STEP, Parasolid, etc.), STL, 3MF or CLI slicing data.

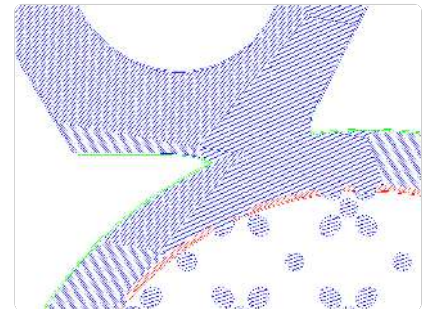

Stabilize Thermal Process

USE THERMAL SIMULATION TO ACHIEVE THERMAL STABILITY

- **Simulate thermal behavior** - Analyze the thermal conditions of the actual “scan-path” for the entire tray, to find thermal instabilities and overheating. Fix such issues automatically by changing the “scan-path,” or manually by changing nesting, orientation or support structure, to avoid poor print quality or build failure.
- **Automatic thermal stabilization** - automatically add delays at critical points to the “scan-path” to avoid overheating and achieve thermal stability.

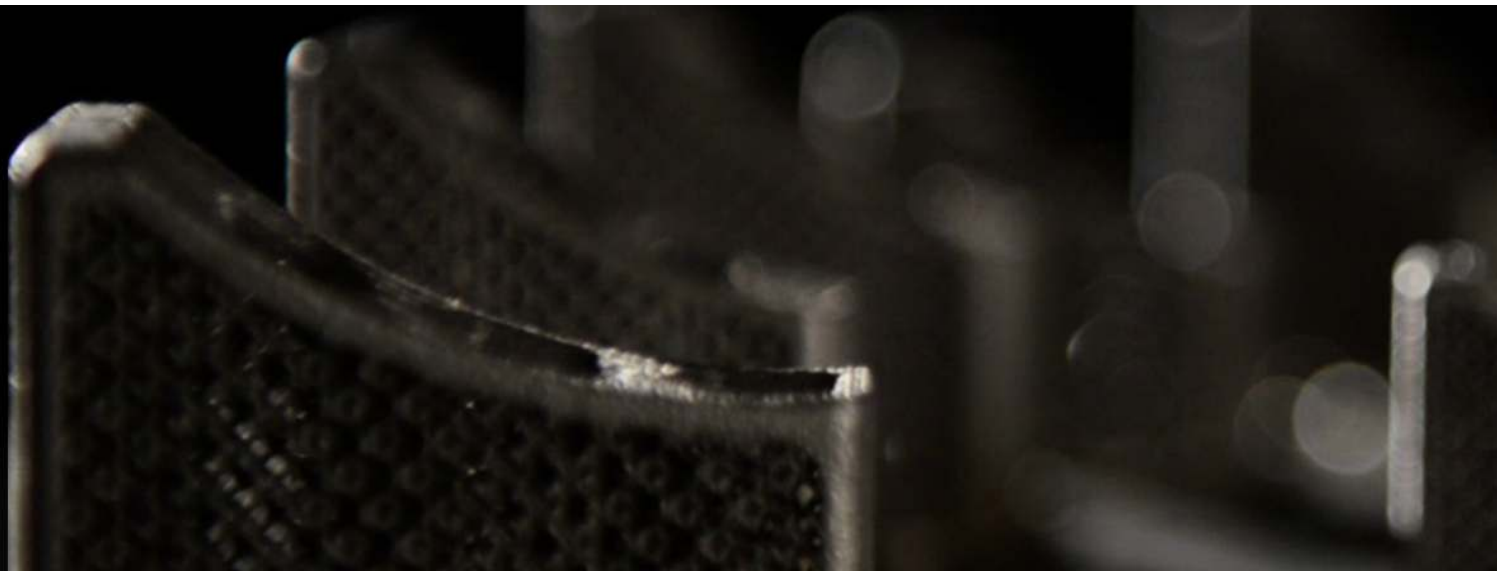
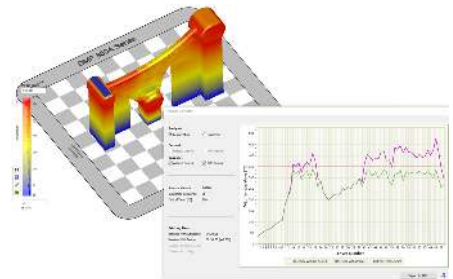



3DXpert

A New Additive Manufacturing Experience

- We reduced file processing times by up to 75% and increased productivity by up to 40%. 3DXpert also allows us to better analyze and plan the part, so we can use less supports and less material which further reduces cost and time.
- Metal Technology Inc.
- With 3DXpert we didn't just shift from using multiple software solutions into one, but we completely changed and streamlined our entire workflow.
- Sharon Tuvia (1982) Ltd.
- 3DXpert is a game changer! Having full control over the printing parameters with the ability to develop our own printing strategies, will take our productivity to a new level.
- Scarlett Inc.
- We chose Oqton because of its expertise in all - 3D ProMetal

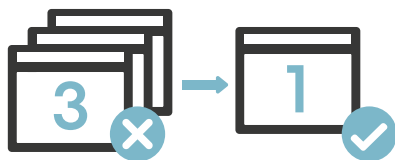

From three different software systems to one

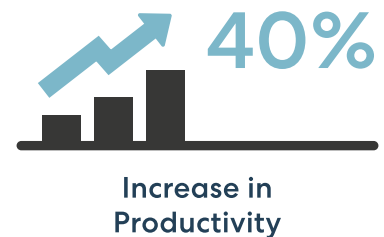
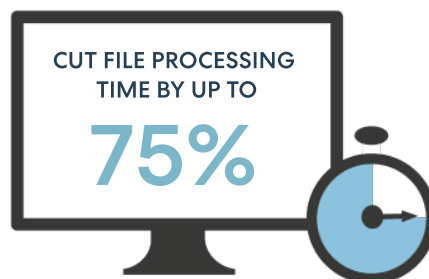

Increase in Productivity



Get In Touch

Contact us for a demo at hello@oqton.com

OQTON